

# Electricity Production Concept Map Images [*cut-outs*]

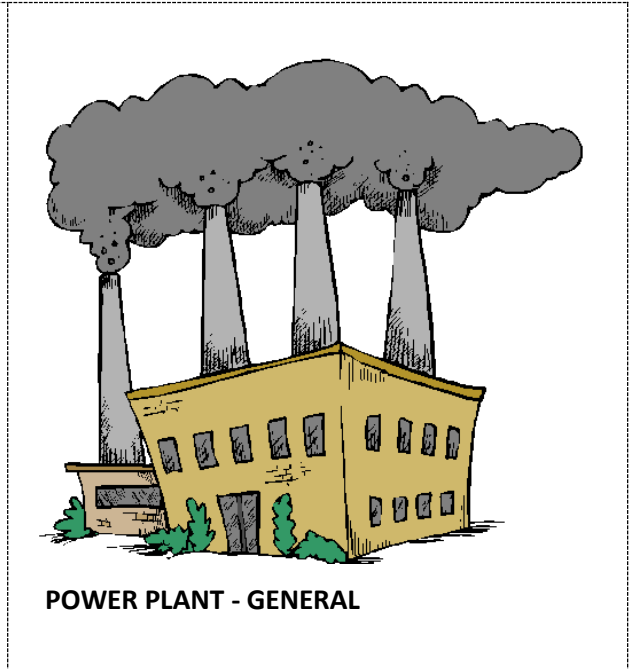

Electricity & Magnetism

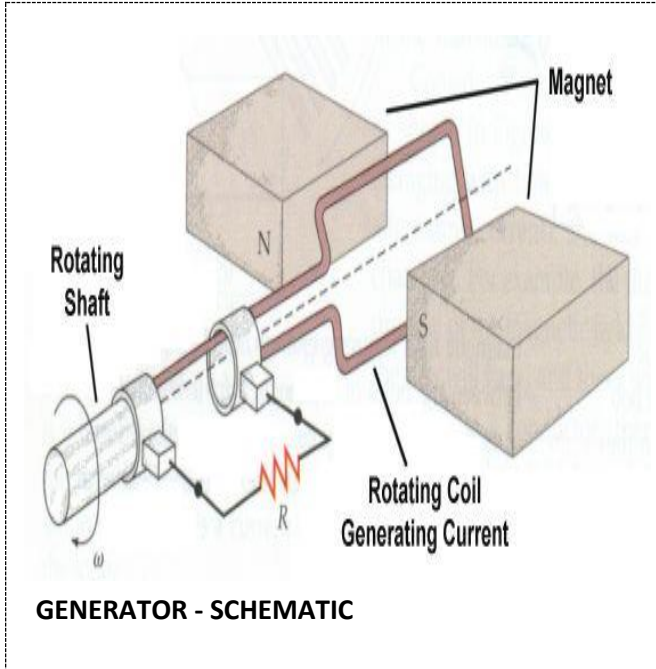
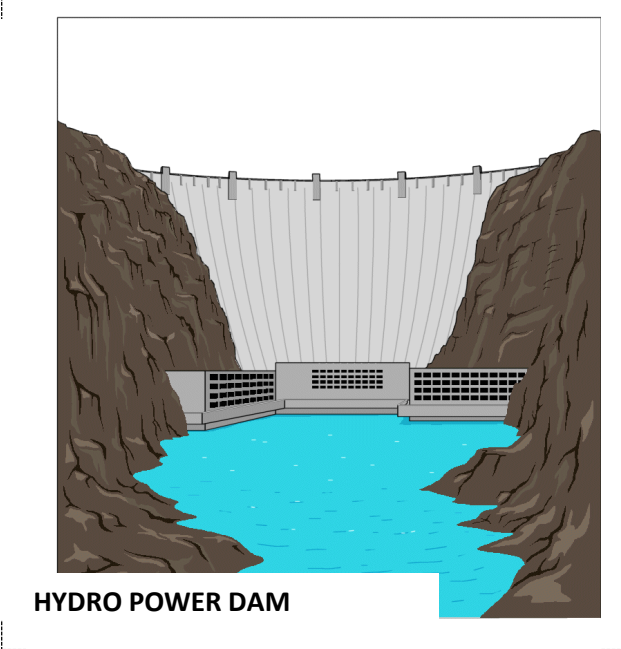
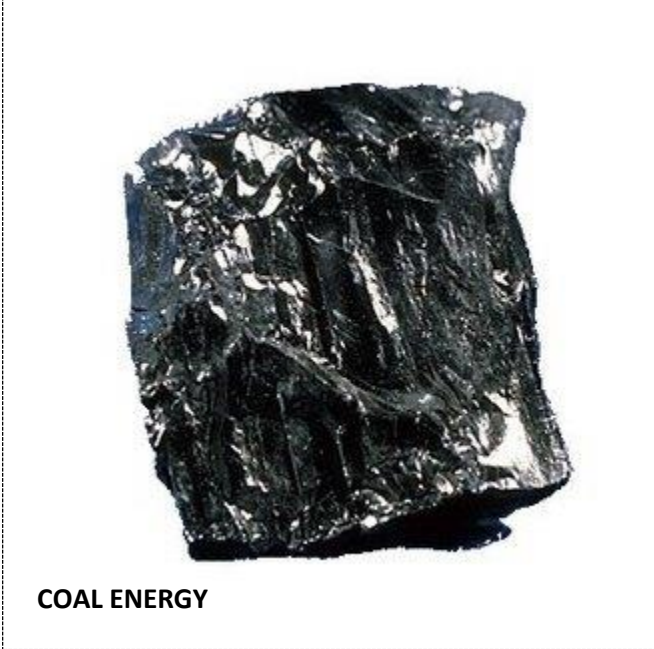
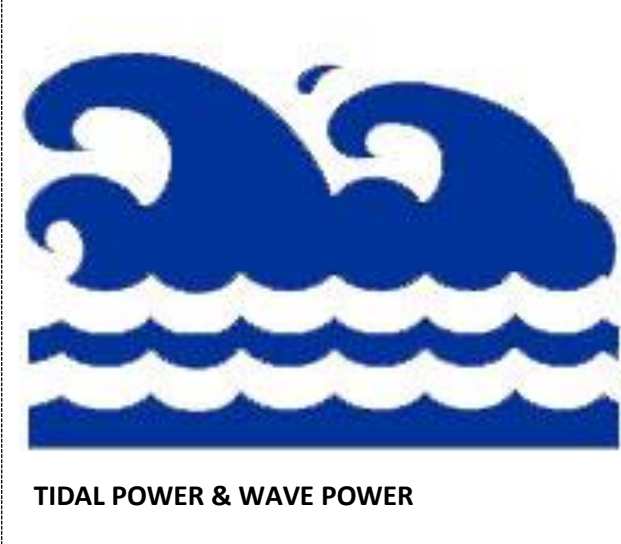
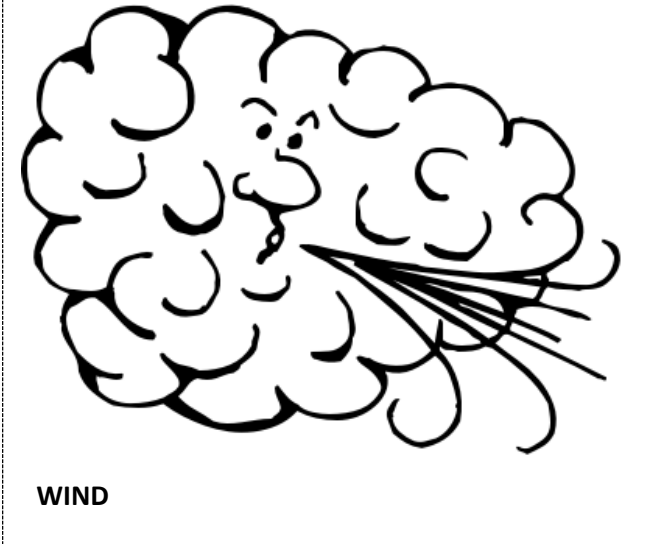
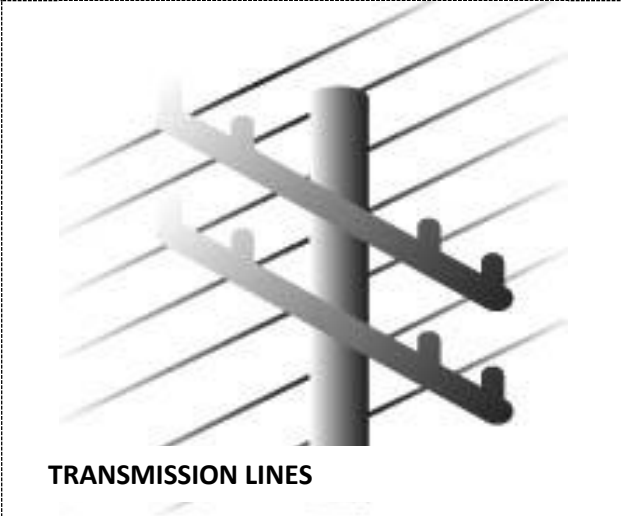

Electricity & Magnetism



WIND TURBINE

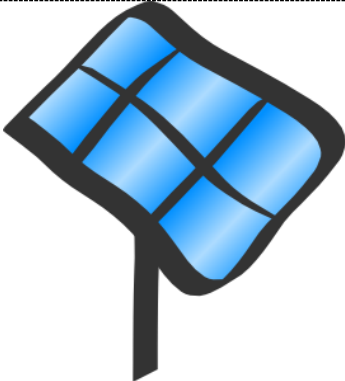

SOLAR CELL – (DIRECT TO HOUSE)



NUCLEAR ENERGY

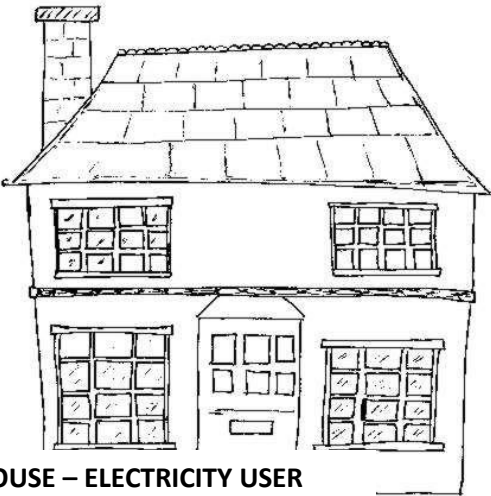



HOUSE – ELECTRICITY USER

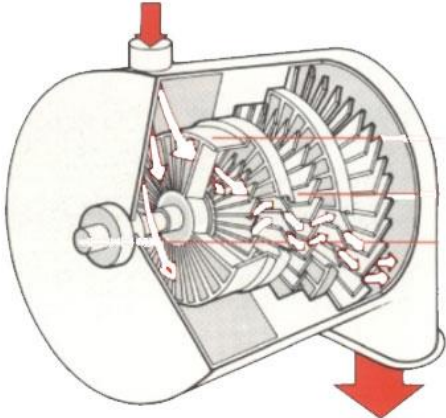

GEOHERMAL ENERGY (creates steam in pipes)

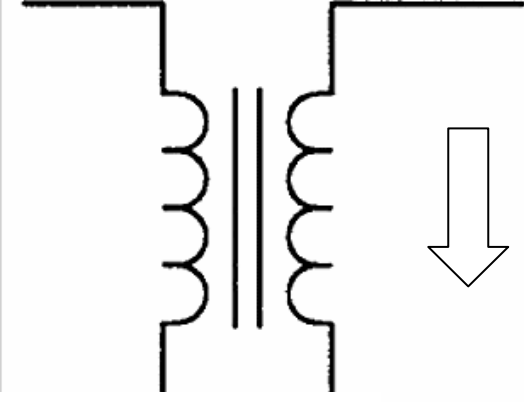
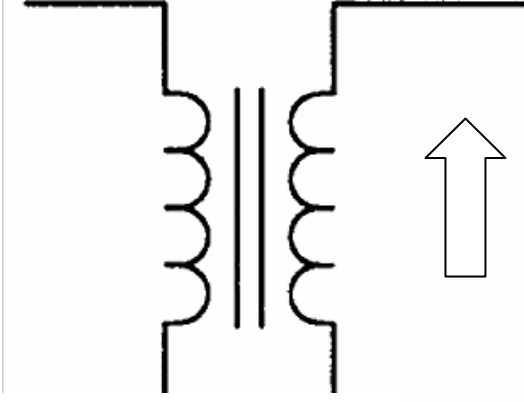
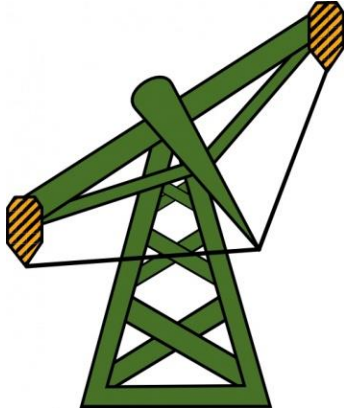
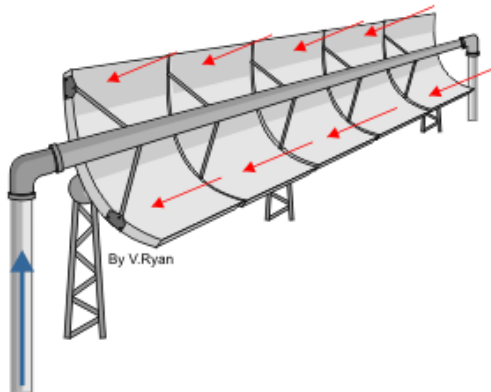

TURBINE

 <p><b>STEP-DOWN TRANSFORMER</b></p>	 <p><b>STEP-UP TRANSFORMER</b></p>
 <p><b>NATURAL GAS PRODUCTION</b></p>	 <p><b>SOLAR POWER (IN-DIRECT)</b></p>
 <p><b>SOLAR FIELD (large scale to transmission lines)</b></p>	 <p><b>INFORMATION AND VIDEOS</b> [<a href="http://bit.ly/18HqgzR">http://bit.ly/18HqgzR</a>]</p>